

Kerotest KM4AP & KM4TP Static Pressure Manifolds

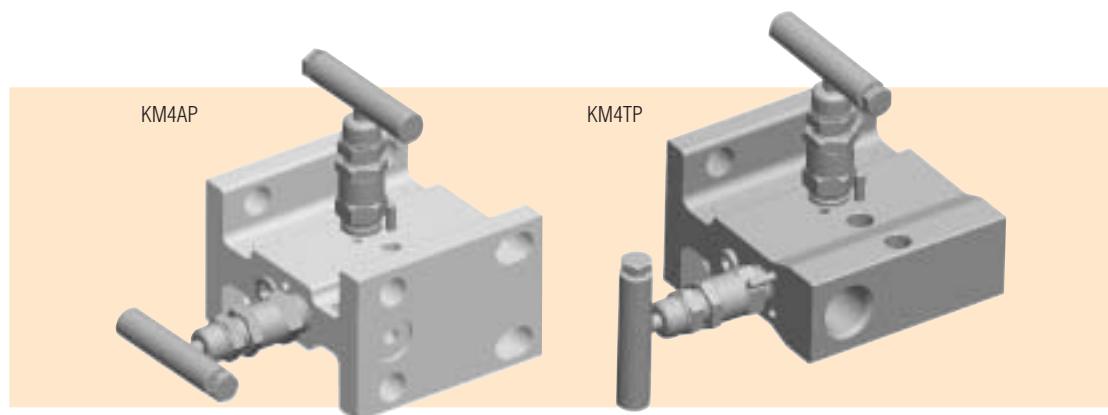

Product Brief

The KM4AP and KM4TP are two-valve, block and bleed style manifolds. These manifolds are intended for static pressure applications and are generally used with Differential Pressure (DP) style pressure transmitters. The block valve isolates the instrument (normally a transmitter) from the process and is normally open in service. When the block valve is closed to isolate the instrument, the bleed valve may be opened to safely vent pressure from the instrument. The KM4AP design permits the process signal line from the transmitter's futbol flange to be connected directly to the manifold. The KM4TP design has a standard 1/2-inch FNPT inlet connection.

Features/Benefits

- **Bubble-tight shutoff.** Every valve is 100% tested.
- **Space-saving design.** One valve replaces two. Less connections means less leak paths means **less fugitive emissions.**
- **Cost-saving design.** Less parts means lower cost in the order of 20-30% compared to conventional two-valve installation.
- **Stem threads** isolated from the process fluid, eliminating process fluid contamination.
- **Direct pipestand mounting.** Requires KMC Mounting Kit. Permits complete piping installation without the transmitter to minimize potential instrument damage during construction.
- **Multiple packing options** available including Teflon® and GRAFOIL®.
- **Ball-tipped stem design** prevents seat galling during valve closure.



An Employee Owned Total Quality Management Company

Kerotest KM4AP & KM4TP Static Pressure Manifolds

Specifications

KM4AP Metal Seat (Soft Seat Available) – Dimensions in Inches (mm)

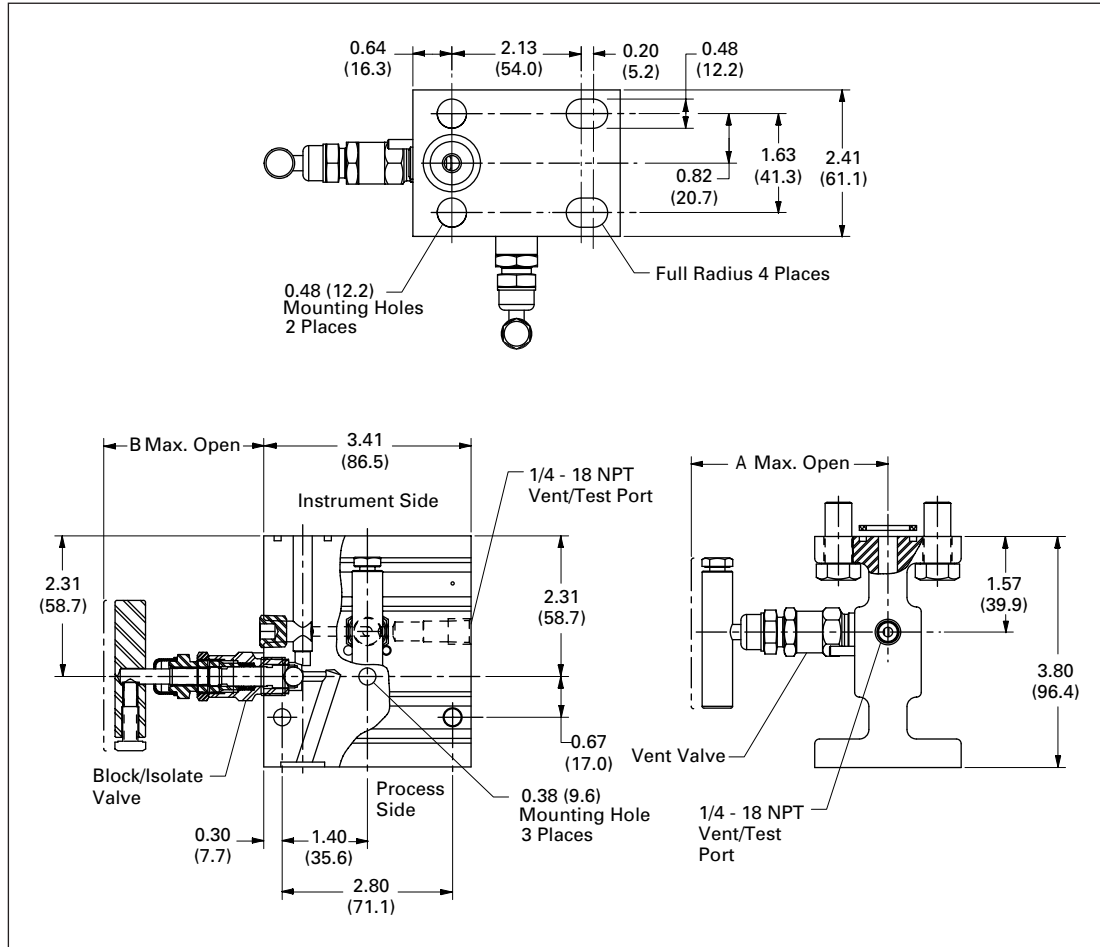

Dimensions in Inches (mm)

Packing	A	B
Teflon	3.14 (79.8)	2.60 (66.0)
GRAFOIL/ Low Emissions Graphite	3.79 (96.3)	3.25 (82.6)

Note: Approximate valve weight: 4.3 lb (2.0 kg).
 Metal Seat: 0.156-inch (4 mm) diameter orifice.
 Cv = .36, full open.
 Soft Seat: 0.187-Inch (4.8 mm) diameter orifice.
 Cv = .83, full open.

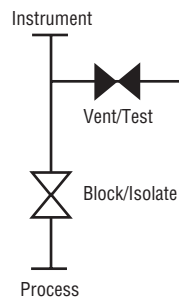

Kerotest KM4AP & KM4TP Static Pressure Manifolds

Specifications

KM4TP Metal Seat (Soft Seat Available) – Dimensions in Inches (mm)

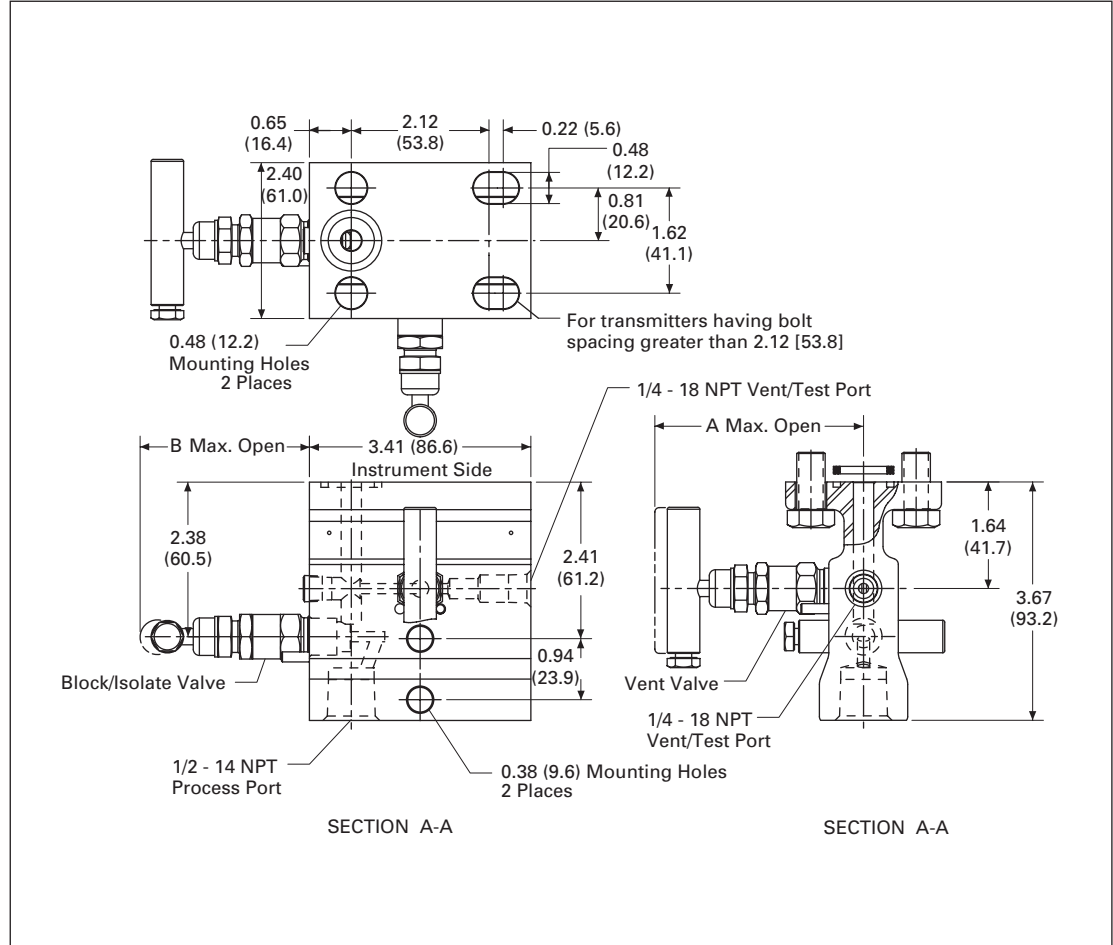

Dimensions in Inches (mm)

Packing	A	B
Teflon	3.14 (79.8)	2.60 (66.0)
GRAFOIL/ Low Emissions Graphite	3.79 (96.3)	3.25 (82.6)

Note: Approximate valve weight: 4.2 lb (1.9 kg).
 Metal Seat: 0.156-inch (4 mm) diameter orifice.
 Cv = .36, full open.
 Soft Seat: 0.187-inch (4.8 mm) diameter orifice.
 Cv = .83, full open.

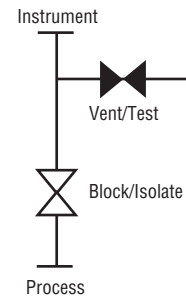

Kerotest KM4AP & KM4TP Static Pressure Manifolds

Standard Materials

Valve	Body	Bonnet	Stem	Ball	Bolts	Packing
CS ①	A576-10L18	A108	A581-303	17-4 PH	A193-B7	Teflon
CS①	A576-10L18	A105	A581-303	17-4 PH	A193-B7	GRAFOIL
316 SS	A479-316	A479-316	A276-316	316 SS	A193-B7	Teflon
316 SS	A479-316	A479-316	A276-316	316 SS	A193-B7	GRAFOIL
SG ②	A479-316	A479-316	Monel 400	Monel K500	A193-B7	Teflon
Monel®	Monel 400	Monel R405	Monel 400	Monel K500	A193-B7	Teflon
SG3 ③	Hastelloy® C276	Hastelloy C276	Hastelloy C276	Stellite	A193-B7	Teflon

Pressure and Temperature Ratings ④

Packing	Valve	Seat	Pressure and Temperature Ratings
Teflon	CS, SS	Delrin®	6000 psig @ 200°F (414 bar @ 93°C)
Teflon	CS, SS	PEEK	6000 psig @ 200°F (414 bar @ 93°C) 2000 psig @ 400°F (138 bar @ 204°C)
Teflon	CS, SS	Teflon	1000 psig @ 150°F (69 bar @ 66°C) 200 psig @ 500°F (14 bar @ 260°C)
Teflon	CS, SS	Integral	6000 psig @ 200°F (414 bar @ 93°C) 4000 psig @ 500°F (276 bar @ 260°C)
Teflon	Monel	Integral	5300 psig @ 200°F (365 bar @ 93°C) 4200 psig @ 500°F (290 bar @ 260°C)
GRAFOIL/Low Emissions Graphite	CS	Integral	6000 psig @ 200°F (414 bar @ 93°C) 4000 psig @ 600°F (276 bar @ 316°C)
GRAFOIL/Low Emissions Graphite	SS	Integral	6000 psig @ 200°F (414 bar @ 93°C) 1500 psig @ 1000°F (103 bar @ 538°C)

① CS is zinc cobalt-plated to prevent corrosion.

② SG (Sour Gas) meets the requirements of NACE MR0175-2002.

③ SG3 (Sour Gas) meets the requirements of NACE MR0175-2003.

④ 316 SS bolts lower pressure ratings to a maximum of 4500 psig (310 bar).

Kerotest KM4AP & KM4TP Static Pressure Manifolds

Pressure vs. Temperature – Soft Seat

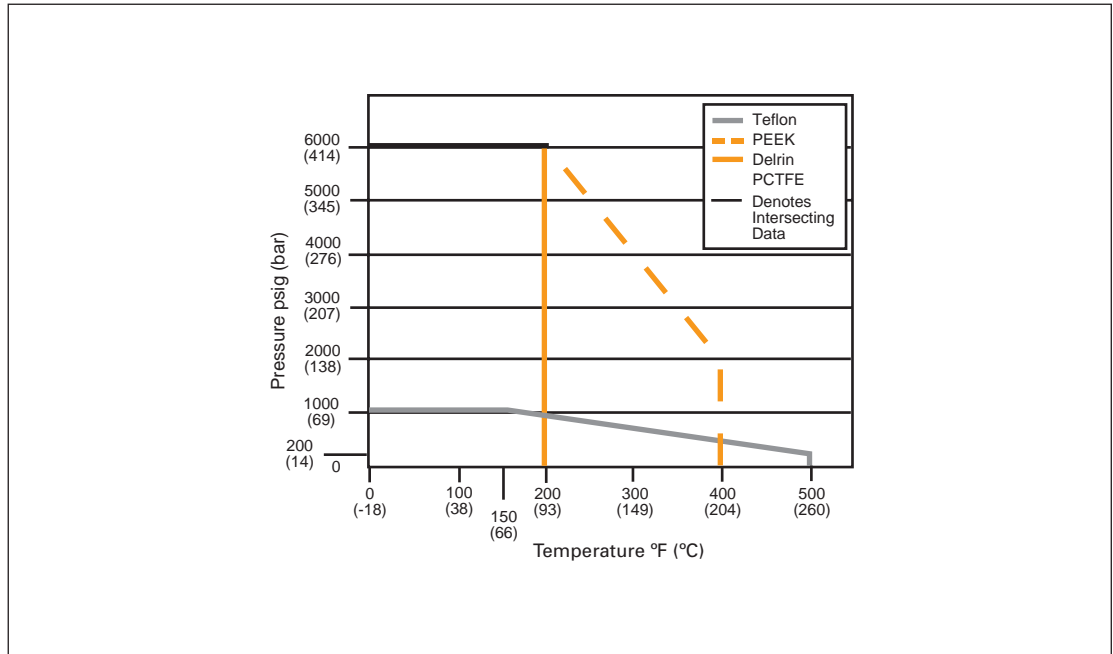

Pressure vs. Temperature – Metal Seat

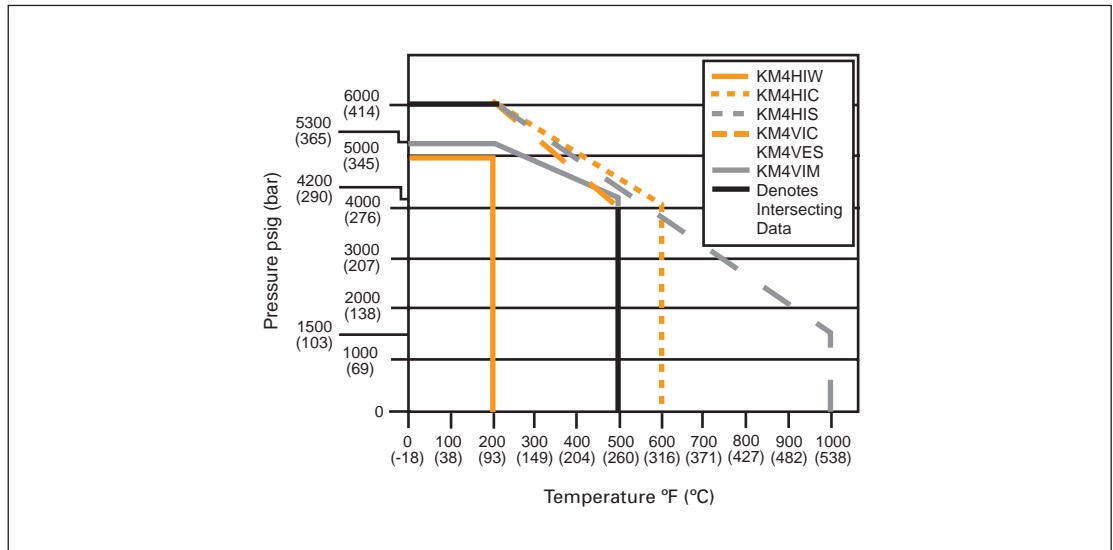

Note: PCTFE (Polychlorotrifluoroethylene) is the exact equivalent of Kel-F®.
 316 SS bolts lower pressure ratings to maximum of 4500 psig (310 bar).

Kerotest KM4AP & KM4TP Static Pressure Manifolds

Ordering Information

KM4TP	<u>V</u>	<u>D</u>	<u>C</u>	-	<u>4</u>	-	<u>AM</u>
1.	2.	3.	4.		5.		6.

<p>1. Valve Type</p> <p>KM4AP – Flange x Flange KM4TP – FNPT x Flange</p>	<p>4. Body Material</p> <p>C – CS W – 316L SS S – 316 SS J – Hastelloy M – Monel</p>	<p>CL – Cleaned for Chlorine Service HD – Hydrostatic Testing (100%) LP – Street Elbows and Top Purge Ports OC – Cleaned for Oxygen Service PB – Bottom Purge Port (Metal Seat Only) PT – Top Purge Port (Metal Seat Only) (If Elbow is Required, Specify LP, not PT) R3V – Add for Use with Rosemount® Model 3051C (SS 18-8 Bolts) SB – Steam Block (CS) SSA^① – SS Flange Bolt (Grade 18-8) – Maximum Pressure Rating 4500 psig (310 bar) SSC – 316 Flange Bolt (B8M) – Maximum Pressure Rating 4500 psig (310 bar) SG – Sour Gas Meets the Requirements of NACE MR0175-2002 (SS Valves Only) SG3 – Sour Gas meets the requirements of NACE MR0175-2003 SP – Special Requirements – Please Specify</p>
<p>2. Bonnet Packing</p> <p>V – Teflon (Soft and Integral Seats) H – GRAFOIL (Integral Seat Only) E – Low Emissions Graphite (Integral Seat Only)</p>	<p>5. Process Connections</p> <p>4 – 1/2-Inch FNPT (KM4TP Only)</p>	
<p>3. Seat Material</p> <p>D – Delrin (Standard) V – Teflon E – PEEK K – PCTFE (Polychlorotrifluoroethylene) is the exact equivalent of Kel-F I – Integral (Body Material)</p>	<p>6. Options</p> <p>AM – KMC Mount Kit for 2-Inch Pipestand Mounting of Manifold BC – Accessory Bracket for Mounting Conduit with KMC Mount BP – Accessory Bracket for Mounting Purge Meters with KMC Mount</p>	

① 316 SS bolts lower pressure ratings to maximum of 4500 psig (310 bar).

Kerotest KM4AP & KM4TP Static Pressure Manifolds

Ordering Information

KM4TPHP <u>S</u> - <u>4</u> - <u>XP</u> - <u>SP</u> 1. 2. 3.		
1. Body Material C – CS, A105 S – 316 SS W – 316L SS J – Hastelloy	2. Process Connections 4 – 1/2-Inch FNPT 4AT – Integral 1/2-Inch Single Ferrule Tube Fittings 316 SS Ferrule and Nut 4ATD – Integral 1/2-Inch Dual Ferrule Tube Fittings 316 SS Ferrule and Nut 4TB – 1/2-Inch Tube S.W. x Flange x 1/4-Inch FNPT	3. Options AM – KMC Mount Kit for 2-Inch Pipestand Mounting of Manifold R3V – Add for use with Rosemount Model 3051C (SS 18-8 Bolts) SB – Steam Block (CS) SSA ^① – SS Flange Bolt (Grade 18-8) – Maximum Pressure Rating 4500 psig (310 bar) SSC ^① – 316 Flange Bolt (B8M) – Maximum Pressure Rating 4500 psig (310 bar) SP – Special Requirements – Please Specify

Note: All manifolds come standard with GRAFOIL packing, integral seats, bonnet locks, and are subjected to hydrostatic testing. KM4TP ASME B31.1 and B31.3 specifications meet MSS-SP-105.

Manifold ratings:

SST	6000 psig @ 100°F	(414 bar @ 38°C)
	2915 psig @ 1000°F	(201 bar @ 538°C)
STL	6170 psig @ 100°F	(425 bar @ 38°C)
	3430 psig @ 800°F	(236 bar @ 427°C)

① 316 SS bolts lower pressure ratings to a maximum of 4500 psig (310 bar).

All product names referenced herein are trademarks of their respective companies.